

SPW-600-D

SPW-600-D Series Features:

- * Rating: 12VA
- * 115/230V 60Hz dual (series/parallel) inputs & outputs, (see schematic notes below).
- * Side-by-side input and outputs (no electrostatic shield required).
- * 100% tested for PRI-SEC hi-pot at 2500VAC, PRI-Core & SEC-Core at 1800VAC.
- * Coated to resist dust and moisture.
- * Same PCB layout as SPW-3600 Series (international-capable).

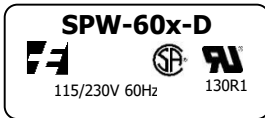
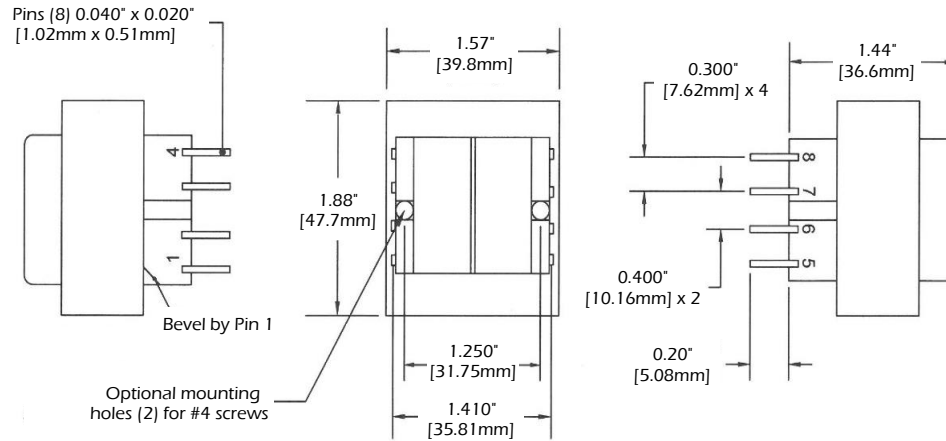

PRI Label

"x" is replaced by last digit of model number

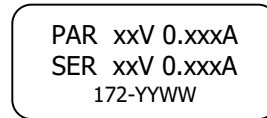

SEC Label

(*YYWW" replaced by current date code)

Dimensions are for reference only.

MODEL	Series Rating	Parallel Rating
SPW-600-D	10VCT @ 1.20A	5V @ 2.40A
SPW-601-D	12.6VCT @ 1.00A	6.3V @ 2.00A
SPW-602-D	16VCT @ 0.80A	8V @ 1.60A
SPW-603-D	20VCT @ 0.60A	10V @ 1.20A
SPW-604-D	24VCT @ 0.50A	12V @ 1.00A
SPW-605-D	28VCT @ 0.42A	14V @ 0.84A
SPW-606-D	36VCT @ 0.35A	18V @ 0.70A
SPW-607-D	48VCT @ 0.25A	24V @ 0.50A
SPW-608-D	56VCT @ 0.22A	28V @ 0.44A
SPW-609-D	120VCT @ 0.10A	60V @ 0.20A

PRI 1 and PRI 2 must ALWAYS be inter-connected, either in parallel or series.
SEC 1 and SEC 2 must ALWAYS be inter-connected, either in parallel or series.

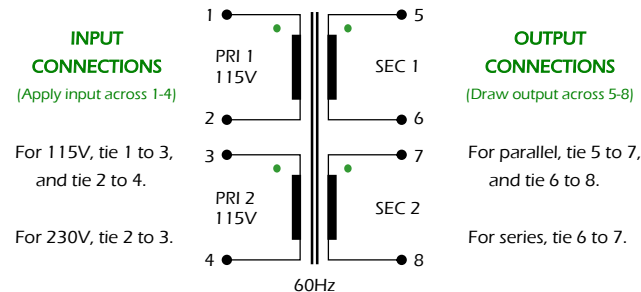

CERTIFICATIONS & DECLARATIONS

- * **UL 5085-2** General Purpose recognized (E47299).
- * **CSA C22.2 #66** certified (063944).
- NOTE: Providing external circuit protection (ie. fusing) to comply with safety agency requirements in the application is the responsibility of the customer.*
- * **UL 1446** Recognized Class B (130°C) Insulation System (File E95662).
- * **RoHS** and **REACH** Compliant.
- * California **Prop 65** warning:

These products may contain chemicals known to the State of California to cause cancer, and birth defects or other reproductive harm.

REV	DATE	DESCRIPTION	BY
0	31-May-2021	Acquired from Prem Magnetics. Released for Production.	SDE

115/230V 60Hz
12VA



A PowerVolt Group Company
Bellevue, Iowa 52031 USA
ISO 9001 Registered since 1998