

ADMIRAL CLASS - INTERNATIONAL QUICK-CONNECT TERMINALS, POWER TRANSFORMER

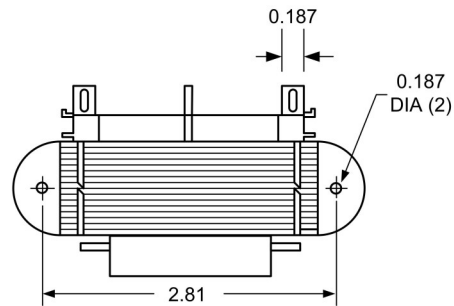
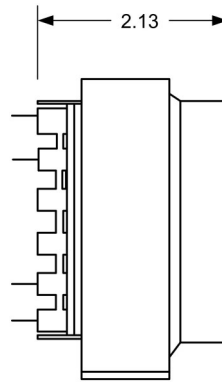
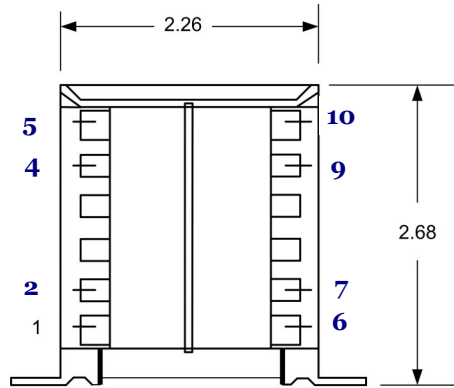

1. Electrical Specifications

- A. Maximum Power: 43VA
- B. Input Voltage and Frequency: 115V, 115/230V, 230V
50/60Hz
- C. Voltage Regulation: ___% TYP @ full load to no load
- D. Temperature Rise: ___°C TYP
- E. Insulation Resistance: _____
- F. Hi-Pot: 4000Vrms 1 minute @ Pri to Sec
_____Vrms 1 minute @ Pri to Core
_____Vrms 1 minute @ Sec to Core

2. Marking: Ensign Corp, part number (see table), date code, terminal numbers

3. Safety:

- UL/cUL 5085-2 Recognized (File E47299)
- UL 60950 Recognized (File E144070)
- TUV Certified (B 016550 0020)
- UL 1446 Recognized Insulation System (File E95662)



Primary Schematics

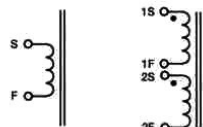

Single Input
(Specify 115V,
120V, 230V or
240V)

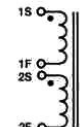

Dual Input
(Specify
115/230V or
120/240V)

Secondary Schematics

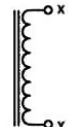

Single
Output

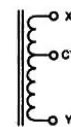

Center-Tapped
Output

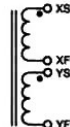

Dual
Output

Part Number			Series Connection	Parallel Connection
115V	115/230V	230V		
IT043-1-010X	IT043-2-010X	IT043-3-010X	10VCT @ 4.3A	5V @ 8.6A
IT043-1-012X	IT043-2-012X	IT043-3-012X	12.6VCT @ 3.4A	6.3V @ 6.8A
IT043-1-016X	IT043-2-016X	IT043-3-016X	16VCT @ 2.7A	8V @ 5.4A
IT043-1-020X	IT043-2-020X	IT043-3-020X	20VCT @ 2.2A	10V @ 4.4A
IT043-1-024X	IT043-2-024X	IT043-3-024X	24VCT @ 1.8A	12V @ 3.6A
IT043-1-028X	IT043-2-028X	IT043-3-028X	28VCT @ 1.5A	14V @ 3.0A
IT043-1-036X	IT043-2-036X	IT043-3-036X	36VCT @ 1.2A	18V @ 2.4A
IT043-1-230X	IT043-2-230X	IT043-3-230X	230VCT @ 0.19A	115V @ 0.38A

	POWER TRANSFORMER ADMIRAL CLASS	IT043-1-XXXX IT043-2-XXXX IT043-3-XXXX	
	CONTENTS OF THIS DRAWING ARE SUBJECT TO CHANGE WITHOUT PRIOR NOTICE	Ensign Corporation 201 ENSIGN RD., BELLEVUE, IA 52031	Dim: Inches
PROPRIETARY NOTICE: THIS DRAWING PRINT OR DOCUMENT AND SUBJECT MATTER DISCLOSED HEREIN ARE PROPRIETARY ITEMS TO WHICH ENSIGN RETAINS THE EXCLUSIVE RIGHT OF DISSEMINATION, MANUFACTURE AND SALE. THIS DRAWING, PRINT OR DOCUMENT IS SUBMITTED IN CONFIDENCE FOR CONSIDERATION BY THE RECIPIENT ALONE UNLESS PERMISSION FOR FURTHER DISCLOSURE IS EXPRESSLY GRANTED IN WRITING			