

SLP-24-350

SLP-24-350 Series Features:

- * Rating: 1.1VA
- * 24V 60Hz input, dual (series/parallel) outputs, (see schematic notes below).
- * Side-by-side input and outputs (no electrostatic shield required).
- * 100% tested for PRI-SEC hi-pot at 2500VAC, PRI-Core & SEC-Core at 1800VAC.
- * Coated to resist dust and moisture.
- * Same PCB layout as SPW-350-S Series (115V input).

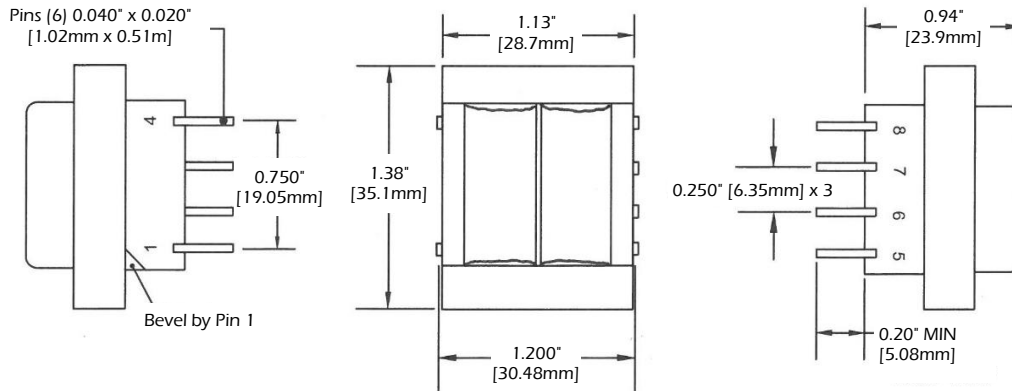

PRI Label

"x" is replaced by last digit of model number

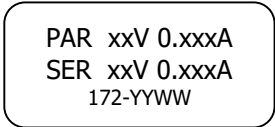

SEC Label

(*YYWW" replaced by current date code)

Dimensions are for reference only.

MODEL	Series Rating	Parallel Rating
SLP-24-350	10VCT @ 0.110A	5V @ 0.220A
SLP-24-351	12.6VCT @ 0.090A	6.3V @ 0.180A
SLP-24-352	16VCT @ 0.070A	8V @ 0.140A
SLP-24-353	20VCT @ 0.055A	10V @ 0.110A
SLP-24-354	24VCT @ 0.045A	12V @ 0.090A
SLP-24-355	28VCT @ 0.040A	14V @ 0.080A

SEC 1 and SEC 2 must ALWAYS be inter-connected, either in parallel or series.

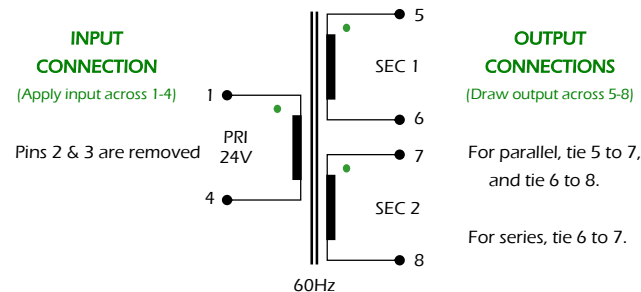

CERTIFICATIONS & DECLARATIONS

- * **UL/cUL 5085-2** General Purpose construction.
NOTE: Providing external circuit protection (ie. fusing) to comply with safety agency requirements in the application is the responsibility of the customer.
- * **UL 1446** Recognized Class B (130°C) Insulation System (File E95662).
- * **RoHS and REACH** Compliant.
- * California **Prop 65** warning:
These products may contain chemicals known to the State of California to cause cancer, and birth defects or other reproductive harm.

REV	DATE	DESCRIPTION	BY
0	31-May-2021	Acquired from Prem Magnetics. Released for Production.	SDE

24V 60Hz
 1.1VA



A PowerVolt Group Company
 Bellevue, Iowa 52031 USA
 ISO 9001 Registered since 1998