

# COMMODORE CLASS - CHASSIS MOUNT WITH QUICK-CONNECT TERMINALS POWER TRANSFORMER

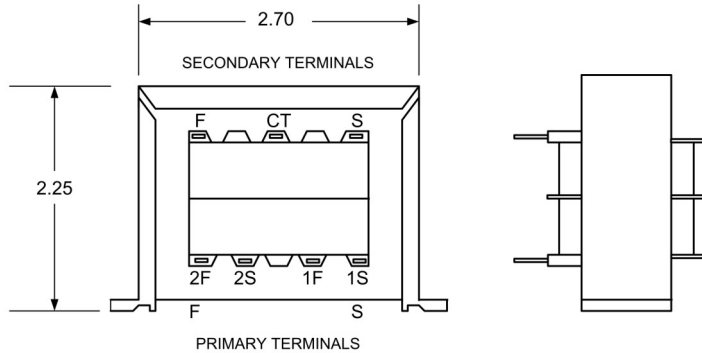

0.187" QUICK-CONNECT OR SOLDER LUG TERMINALS

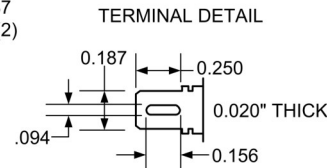
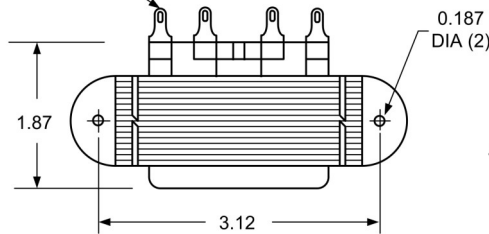

## Primary Schematics

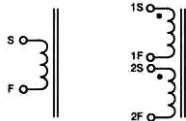

**Single Input**  
(Specify 115V,  
120V, 230V or  
240V)

**Dual Input**  
(Specify  
115/230V or  
120/240V)

## Secondary Schematics

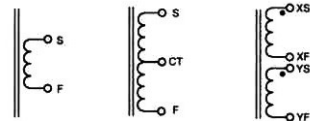

**Single Output**

**Center-Tapped Output**

**Dual Output**

## 1. Electrical Specifications

- A. Maximum Power: 50VA
- B. Input Voltage and Frequency: 115V, 115/230V or 230V 50/60Hz
- C. Voltage Regulation: 10% TYP @ full load to no load
- D. Temperature Rise: 40°C TYP
- E. Insulation Resistance: < 1 MEG ohm
- F. Hi-Pot: 2500Vrms 1 minute @ Pri to Sec  
2500Vrms 1 minute @ Pri to Core  
1500Vrms 1 minute @ Sec to Core

## 2. Marking: Ensign Corp, part number (see table), date code, country, terminal number

## 3. Safety:

UL/cUL 5085-2 Recognized (File 47299)

UL 1446 Recognized Insulation System (File 95662)



Part Number			Secondary
115V	115/230V	230V	
T050-1-510X	T050-2-510X	T050-3-510X	10VCT @ 5.0A
T050-1-512X	T050-2-512X	T050-3-512X	12.6VCT @ 4.0A
T050-1-516X	T050-2-516X	T050-3-516X	16VCT @ 3.1A
T050-1-520X	T050-2-520X	T050-3-520X	20VCT @ 2.5A
T050-1-524X	T050-2-524X	T050-3-524X	24VCT @ 2.1A
T050-1-528X	T050-2-528X	T050-3-528X	28VCT @ 1.8A
T050-1-536X	T050-2-536X	T050-3-536X	36VCT @ 1.4A
T050-1-548X	T050-2-548X	T050-3-548X	48VCT @ 1.0A
T050-1-556X	T050-2-556X	T050-3-556X	56VCT @ 890mA
T050-1-620X	T050-2-620X	T050-3-620X	120VCT @ 420mA



**POWER TRANSFORMER  
COMMODORE CLASS**

**T050-1-XXXX  
T050-2-XXXX  
T050-3-XXXX**

CONTENTS OF THIS DRAWING ARE SUBJECT TO CHANGE WITHOUT PRIOR NOTICE

**Ensign Corporation**  
201 ENSIGN RD., BELLEVUE, IA 52031

Dim: Inches

Sheet 1 of 1

PROPRIETARY NOTICE: THIS DRAWING PRINT OR DOCUMENT AND SUBJECT MATTER DISCLOSED HEREIN ARE PROPRIETARY ITEMS TO WHICH ENSIGN RETAINS THE EXCLUSIVE RIGHT OF DISSEMINATION, MANUFACTURE AND SALE. THIS DRAWING, PRINT OR DOCUMENT IS SUBMITTED IN CONFIDENCE FOR CONSIDERATION BY THE RECIPIENT ALONE UNLESS PERMISSION FOR FURTHER DISCLOSURE IS EXPRESSLY GRANTED IN WRITING