

SPW-610-S

SPW-610-S Series Features:

- * Rating: 20VA
- * 115V 60Hz input, dual (series/parallel) outputs, (see schematic notes below).
- * Side-by-side input and outputs (no electrostatic shield required).
- * 100% tested for PRI-SEC hi-pot at 2500VAC, PRI-Core & SEC-Core at 1800VAC.
- * Coated to resist dust and moisture.

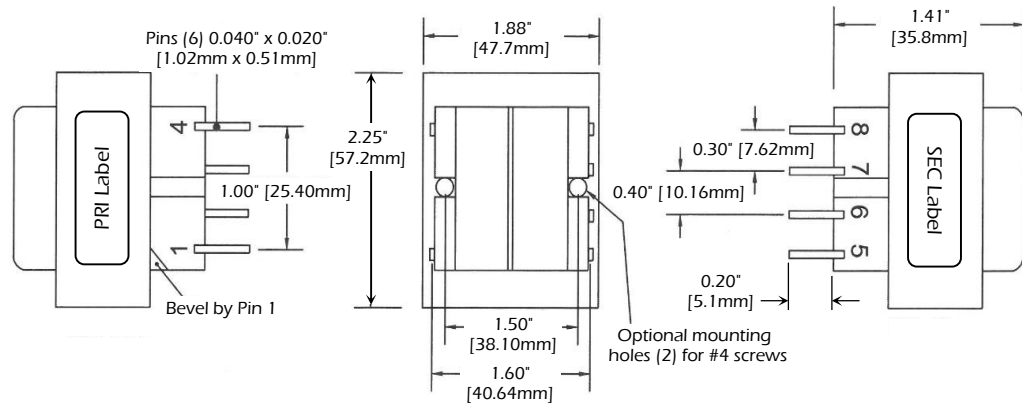

PRI Label

"x" is replaced by last digit of model number

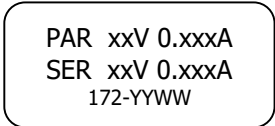

SEC Label

(*YYWW" replaced by current date code)

Dimensions are for reference only.

MODEL	Series Rating	Parallel Rating
SPW-610-S	10VCT @ 2.00A	5V @ 4.00A
SPW-611-S	12.6VCT @ 1.60A	6.3V @ 3.20A
SPW-612-S	16VCT @ 1.25A	8V @ 2.50A
SPW-613-S	20VCT @ 1.00A	10V @ 2.00A
SPW-614-S	24VCT @ 0.80A	12V @ 1.60A
SPW-615-S	28VCT @ 0.70A	14V @ 1.40A
SPW-616-S	36VCT @ 0.55A	18V @ 1.10A
SPW-617-S	48VCT @ 0.40A	24V @ 0.80A
SPW-618-S	56VCT @ 0.35A	28V @ 0.70A
SPW-619-S	120VCT @ 0.16A	60V @ 0.32A

SEC 1 and SEC 2 must ALWAYS be inter-connected, either in parallel or series.

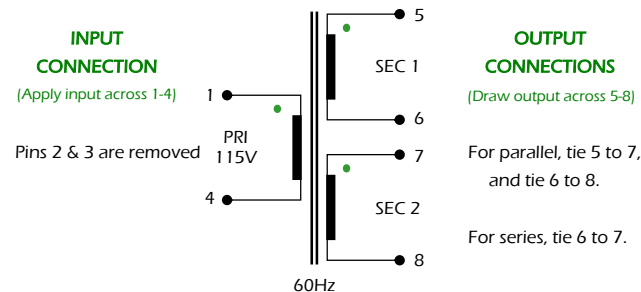

CERTIFICATIONS & DECLARATIONS

- * **UL 5085-2** General Purpose recognized (E47299).
- * **CSA C22.2 #66** Certified (063944).
- NOTE: Providing external circuit protection (ie. fusing) to comply with safety agency requirements in the application is the responsibility of the customer.*
- * **UL 1446** Recognized Class B (130°C) Insulation System (File E95662).
- * **RoHS** and **REACH** Compliant.
- * California **Prop 65** warning:

These products may contain chemicals known to the State of California to cause cancer, and birth defects or other reproductive harm.

REV	DATE	DESCRIPTION	BY
0	31-May-2021	Acquired from Prem Magnetics. Released for Production.	SDE

115V 60Hz
20VA



A PowerVolt Group Company
Bellevue, Iowa 52031 USA
ISO 9001 Registered since 1998