

CSLP-24-600

CERTIFICATIONS & DECLARATIONS

* **UL/cUL 5085-2** General Purpose construction.
NOTE: Providing external circuit protection (ie. fusing) to comply with safety agency requirements in the application is the responsibility of the customer.

* **UL 1446** Recognized Class B (130°C) Insulation System (File E95662).

* **RoHS** and **REACH** Compliant.

* California **Prop 65** warning:

These products may contain chemicals known to the State of California to cause cancer, and birth defects or other reproductive harm.

CSLP-24-600 Series Features:

- * Rating: 12VA
- * 24V 60Hz input, center-tapped output, (see schematic notes below).
- * Side-by-side input and outputs (no electrostatic shield required).
- * 100% tested for PRI-SEC hi-pot at 2500VAC, PRI-Core & SEC-Core at 1800VAC.
- * Coated to resist dust and moisture.
- * Chassis-mounted version of SLP-24-500 Series (PCB pins).

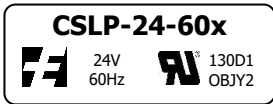
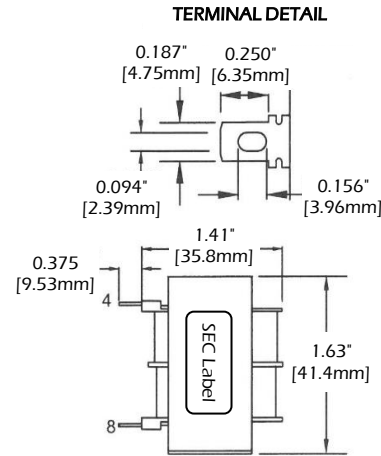
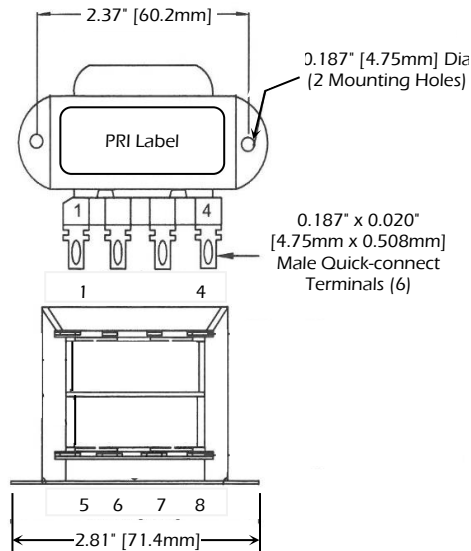

PRI Label

"x" is replaced by last digit of model number

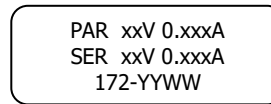

SEC Label

(*YYWW* replaced by current date code)

Dimensions are for reference only.

MODEL	Series Rating	Parallel Rating
CSLP-24-600	10VCT @ 1.20A	5V @ 2.40A
CSLP-24-601	12.6VCT @ 1.00A	6.3V @ 2.00A
CSLP-24-602	16VCT @ 0.80A	8V @ 1.60A
CSLP-24-603	20VCT @ 0.60A	10V @ 1.20A
CSLP-24-604	24VCT @ 0.50A	12V @ 1.00A
CSLP-24-605	28VCT @ 0.42A	14V @ 0.84A

SEC 1 and SEC 2 must ALWAYS be inter-connected, either in parallel or series.

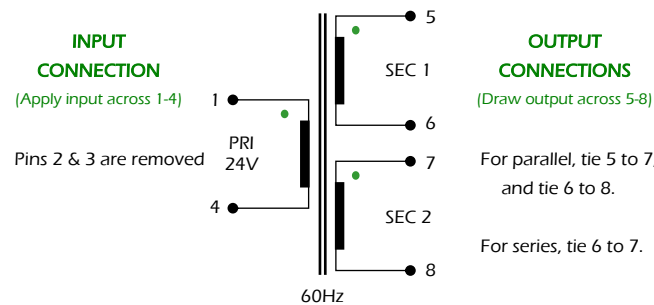

REV	DATE	DESCRIPTION	BY
0	31-May-2021	Acquired from Prem Magnetics. Released for Production.	SDE

24V 60Hz
12VA



A PowerVolt Group Company
 Bellevue, Iowa 52031 USA
 ISO 9001 Registered since 1998